

HANDRAIL WORKSHEET **FLATSOLID**

Typical configurations are shown in bold, or select options

To clear form, go to menu > File > Revert

1 Width:	1.5" x .375" (38.10mm x 9.53mm) AHS1500	6.0" x .375" (152.40mm x 9.53mm) AHS6000
	2.0" x .375" (50.80mm x 9.53mm) AHS2000	8.0" x .375" (203.20mm x 9.53mm) AHS8000 S
	3.0" x .375" (76.20mm x 9.53mm) AHS3000	10.0" x .375" (254.00mm x 9.53mm) AHS10000 S
	4.0" x .375" (101.60mm x 9.53mm) AHS4000	12.0" x .375" (304.80mm x 9.53mm) AHS12000 S





Note: Not all design options are available for all widths; please check our website or call for details.

2 Material/Finish:	Brushed (#4) Polished (#8)	Optional CerinoX Coating:	CerinoX is a ceramic coating over Stainless brushed.
	S4..... S8..... Stainless Steel (304 alloy)	Onyx Black (gloss) CX1	
	B4..... B8..... Bronze (385 alloy)*	StormTrooper White (gloss) CX2	
	Y4..... Y8..... Yellow Brass (260 alloy)*	Burnt Bronze (matte) CX3	
	C4..... C8..... Copper (122 alloy)*	Charcoal Bronze (matte) CX4	

*Clear CerinoX is applied on all Bronze, Brass and Copper alloys unless requested otherwise.

3 Spacer Mount:	Barrel 1.25" (31.75mm) Diameter BL-F	Spacer Installation:	In-Cab (removable) IR
	Barrel 1.5" (38.10mm) Diameter BX-F		Exterior Mounting IX
	Soft Square 1.25" (31.75mm) SQ-F		

4 Select Rail Ends and Specify Measurements:

		Imperial	Metric
Qty:			
ST Straight	←6" Std→ ----- Indicate additional spacers with an "X". Fill in measurements between each spacer. -----		Straight ST
BR Bent		Overall Length: _____	Bent BR
BK Kick			Kick BK
Qty:			
ST Straight	←6" Std→ ----- Indicate additional spacers with an "X". Fill in measurements between each spacer. -----		Straight ST
BR Bent		Overall Length: _____	Bent BR
BK Kick			Kick BK
Qty:			
ST Straight	←6" Std→ ----- Indicate additional spacers with an "X". Fill in measurements between each spacer. -----		Straight ST
BR Bent		Overall Length: _____	Bent BR
BK Kick			Kick BK
Qty:			
ST Straight	←6" Std→ ----- Indicate additional spacers with an "X". Fill in measurements between each spacer. -----		Straight ST
BR Bent		Overall Length: _____	Bent BR
BK Kick			Kick BK

5 Additional Notes/Details/Specifications:

QUOTE FOR:	SHIP TO:	SUBMIT FORM:
Company: _____	Address: _____	
Contact: _____		
E-mail: _____	Country: _____ Zip/Postal Code: _____	OR
Job Name: _____	Tel: _____ Fax: _____	
PO #: _____	Freight: Add Shipping On Account # _____	

FLAT SOLID BAR ENGINEERING DATA (AHS1500-12000 SERIES)

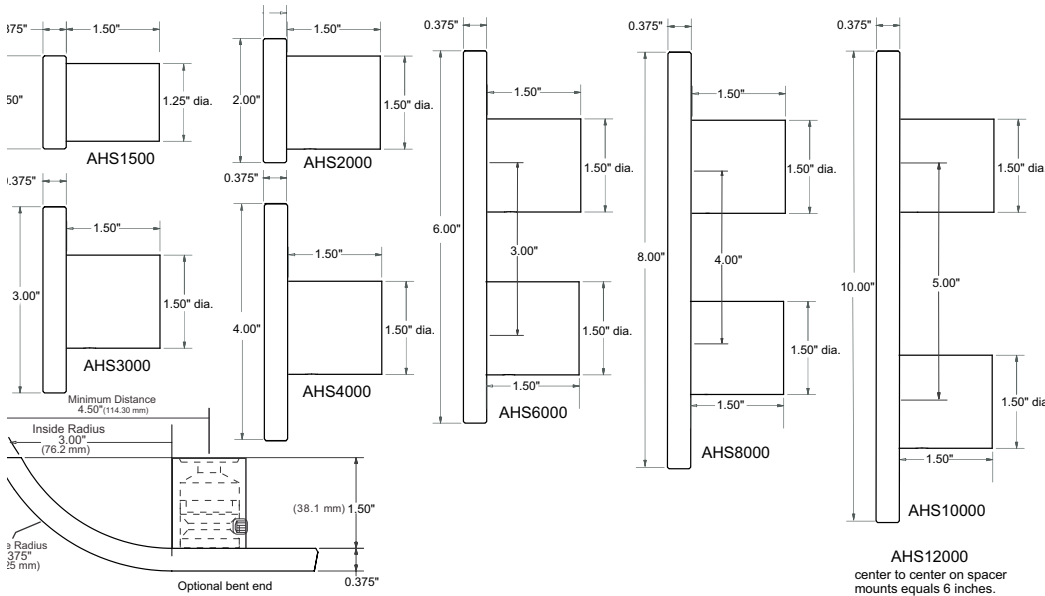

Weights (Stainless/Brass/Bronze)				
BAR WIDTH	ACTUAL WEIGHT		SHIPPING WEIGHTS	
	/foot	/30.48cm	/foot	/30.48cm
1.5"	2.36 lbs	1.07 KG	2.45 lbs	1.11 KG
2.0"	3.05 lbs	1.38 KG	2.45 lbs	1.42 KG
3.0"	4.33 lbs	1.97 KG	4.42 lbs	2.00 KG
4.0"	5.80 lbs	2.63 KG	6.89 lbs	3.13 KG
6.0"	7.98 lbs	3.62 KG	9.07 lbs	4.12 KG
			crate	
8.0"	11.60 lbs	5.26 KG	13.20 lbs	6.26 KG
			crate	
10.0"	14.60 lbs	6.64 KG	16.80 lbs	7.68 KG
			crate	
12.0"	17.40 lbs	7.89 KG	19.20 lbs	8.70 KG
			crate	

IN CAB (REMOVABLE) INSTALLATION SPACER

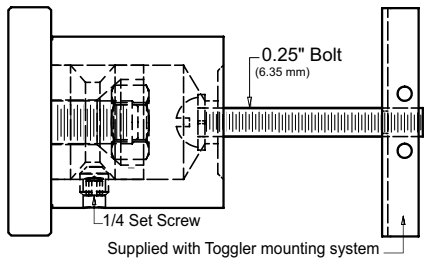

PULL-OUT VALUES for 1/4"- 20 BOLT

265 lbs (120 kg) ultimate tensile load in 1/2" drywall
 306 lbs (162 kg) ultimate tensile load in 5/8" drywall
 925 lbs (420 kg) ultimate tensile load in concrete block
 1,283 lbs (583 kg) ultimate tensile load in steel plate

Tests by independent test laboratory show ultimate load. Industry safety standards recommend 1/4 of the values for actual applications. Age and conditions of substrate will cause load values to vary.

In Cab Removable Handrail Spacer Installation Instructions

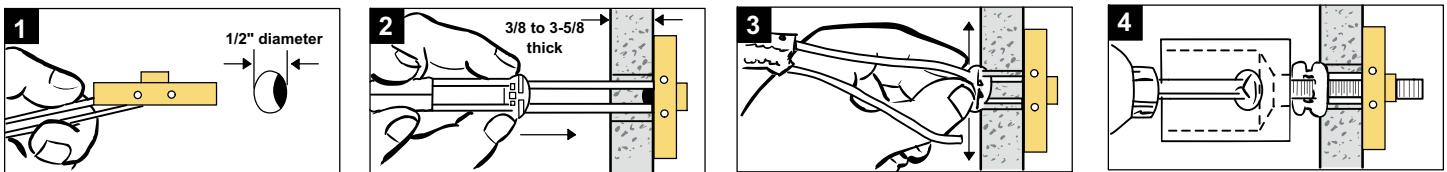

EXTERIOR CAB INSTALLATION SPACER

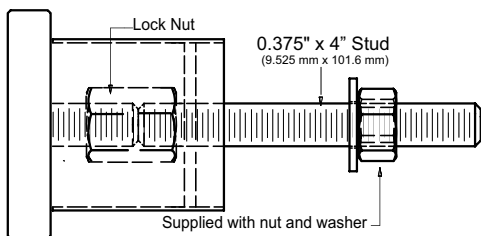

PULL-OUT VALUES for 3/8" STUD

Handrail Thread-lock fastener engineered test data
 Pull-out values for removal of threaded fasteners
 from Lustre Products' handrails = 1509 lbs

CARE & MAINTENANCE for BRASS, BRONZE & COPPER HANDRAILS

PLEASE NOTE: These handrails & components have a spray lacquer coating. To clean and maintain this lacquer coating: gently clean with a soft cloth, dampened with non-abrasive soap and water. Brass or Bronze is a HIGH MAINTENANCE FINISH. Yellow metals will all naturally oxidize / tarnish with time and use. As the lacquer coating applied to your handrail(s) will wear, please note the following:

1. The original lacquer coating can be removed with standard xylene or lacquer thinner (available at most hardware stores – follow all related safety precautions)
2. Normal maintenance (polishing / buffing / Scotch-Brite satin finishing) procedures for Brass or Bronze will result in maintaining the #4 (brushed) or #8 (polished) finish.
3. Continue hand maintenance to control oxidation as well as normal wear and tear using Scotch-Brite pads, Brasso, Miracle Shine, or other commercial metal polish.

THIS LACQUER COATING IS NOT WARRANTIES.